

TN-UHF-CBL-HF240-RPTNC-2-SMA

Accessories – Coaxial Cable for Passive UHF Antennas

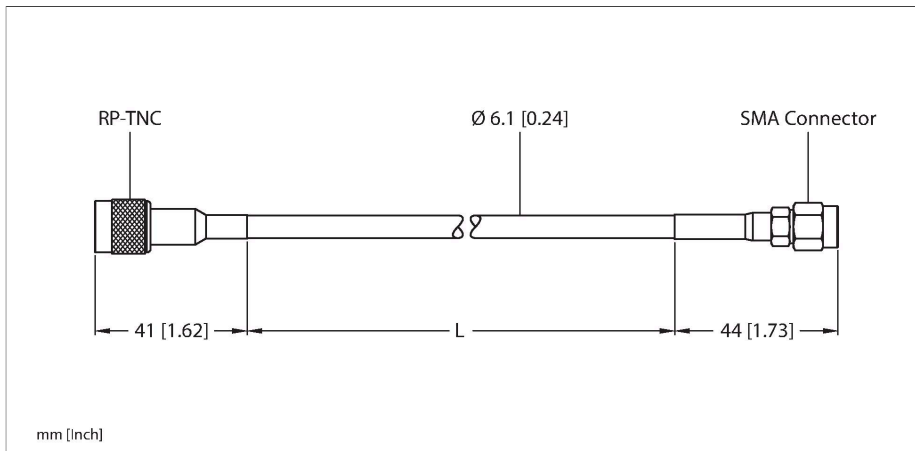

Technical data

Type	TN-UHF-CBL-HF240-RPTNC-2-SMA
ID	100028192
Cable quality	2 m
Damping	0.5 dB
Packaging unit	1

Features

- RP-TNC to SMA